

# KARAG

bathroom experience...

## ERATO S9221

Οδηγίες εγκατάστασης • Installation instructions • Manuali di installazione

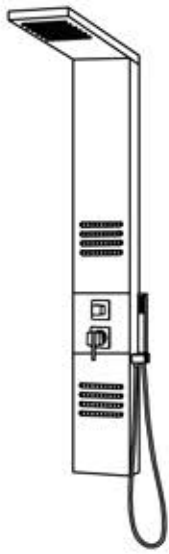

Step 1

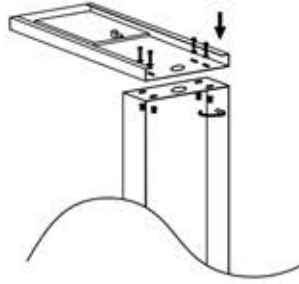

Step 2

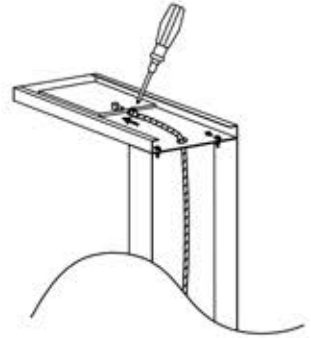

Step 3

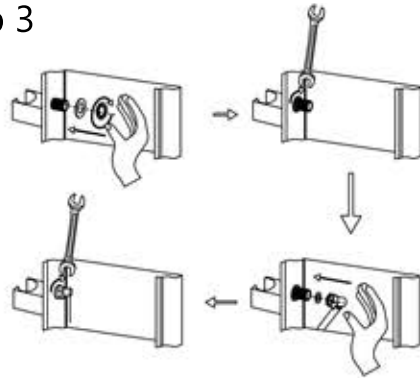

Step 4

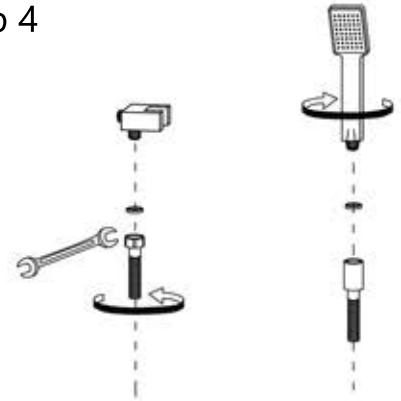

Step 3

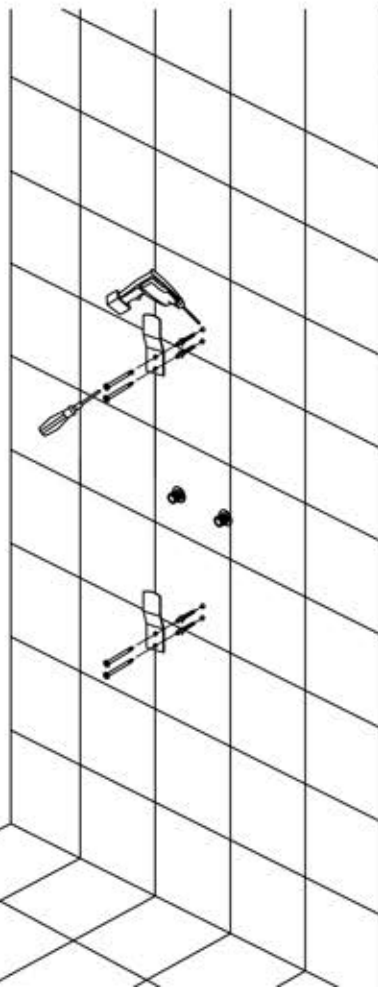
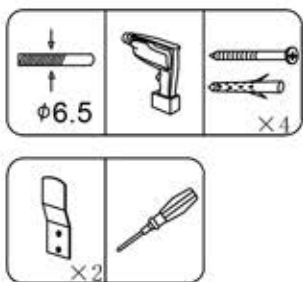

Step 4

