

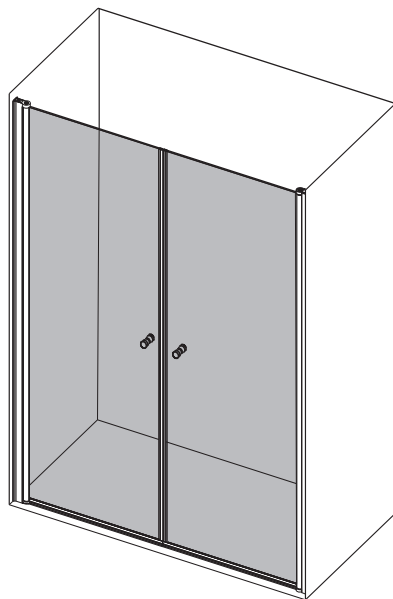













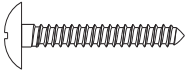



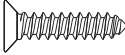





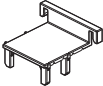



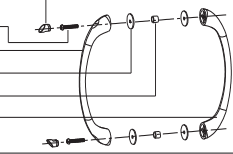

3-8

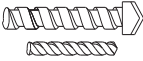

9-14

NO.	Designation	Pieces	NO.	Designation	Pieces
1		X 2	10 1		X 2
2		X 2	10 2		X 2
3	 $\varnothing 8$	X 6+1	11 1		X 2
4	 $\oplus$ ST4X35	X 6+1	11 2		X 2
5	 $\oplus$ ST4X10	X 4+1	12		X 2
6	 $\oplus$ ST4X30	X 4+1	A1		X 2
7		X 4+1	A2		X 4
8		X 2	A3		X 8
9		X 2	A4		X 4
			B1		X 4
			B2		X 4
			B3		X 2
			B4		X 2
			13		X 4
			C1		X 4
			C2		X 4
			C3		X 2
			C4		X 8
			C5		X 4
			C6		X 2
			D	No handle	
				 $\varnothing 8$  $\varnothing 3.2$	

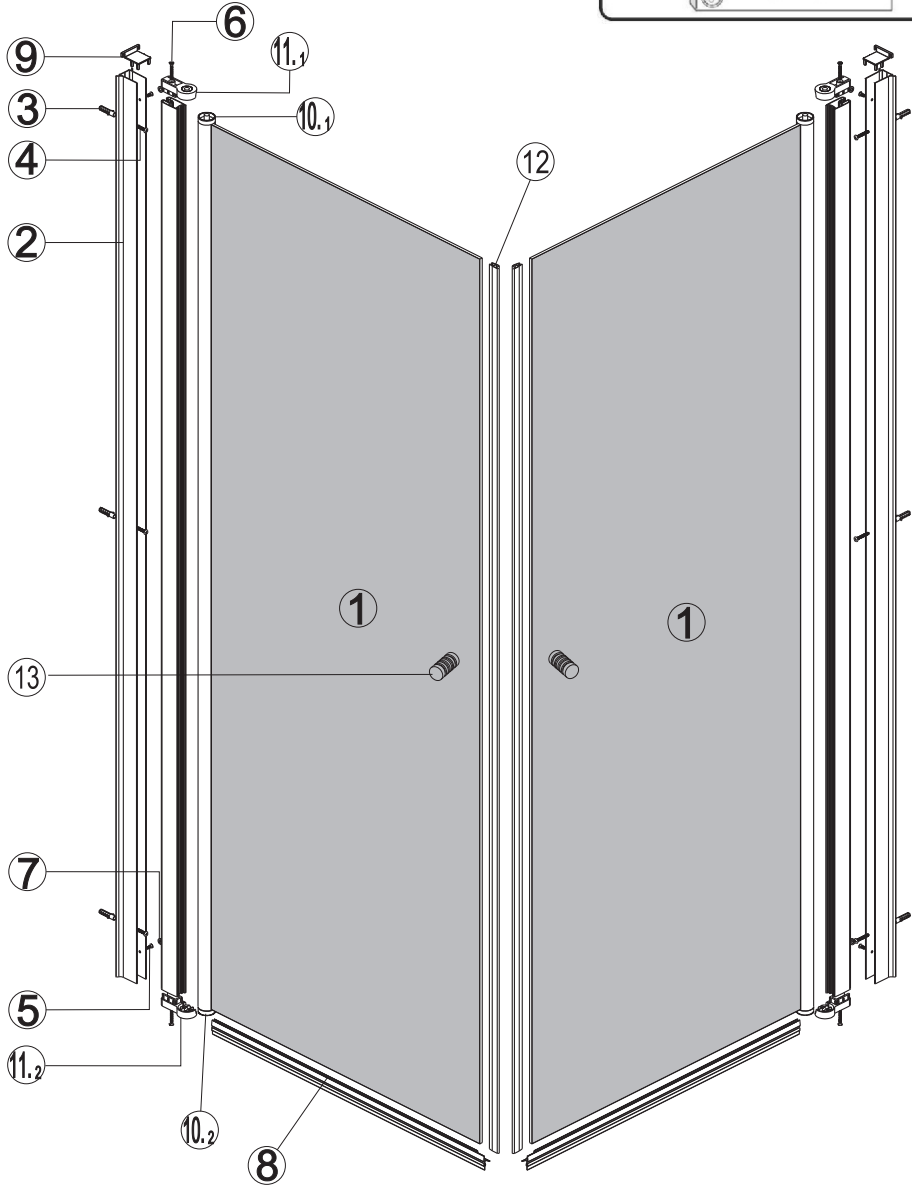
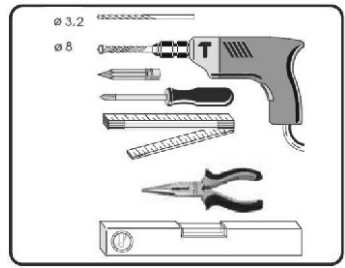
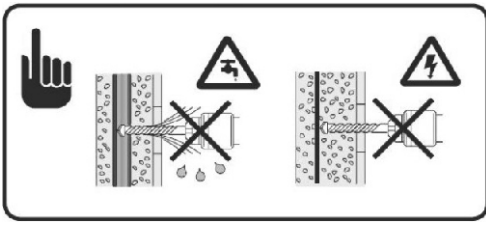

1.

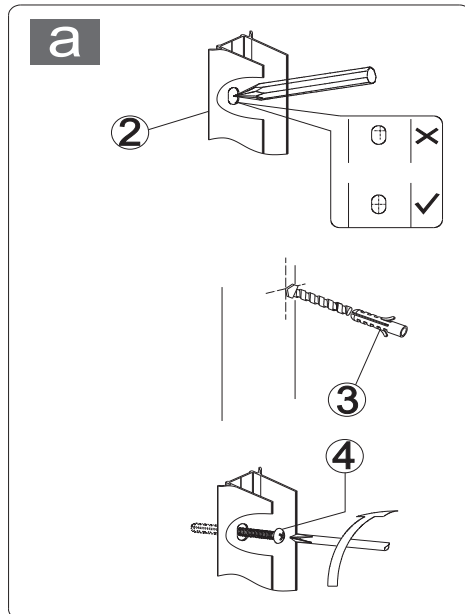
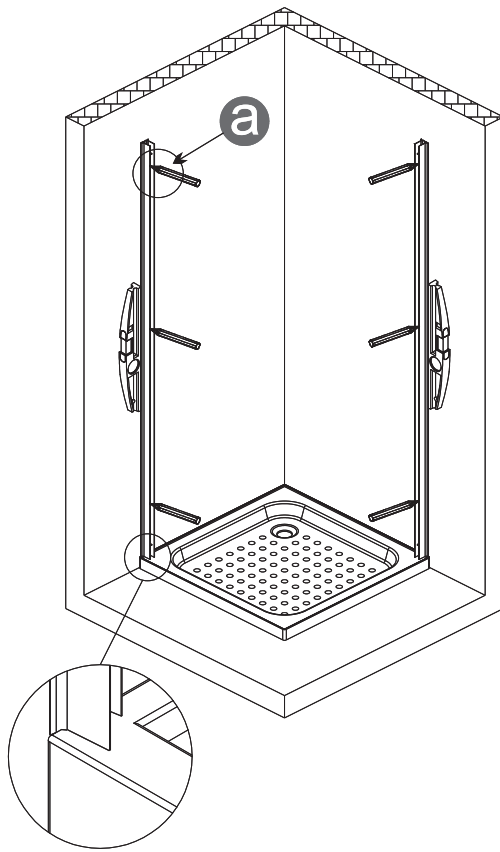

2.

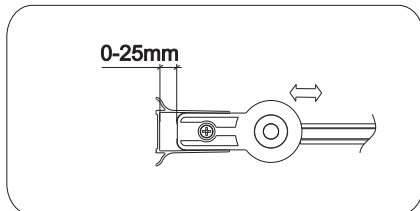
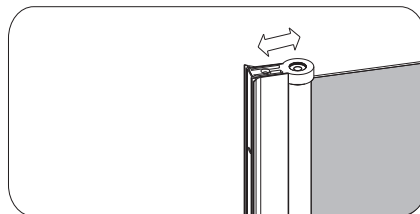
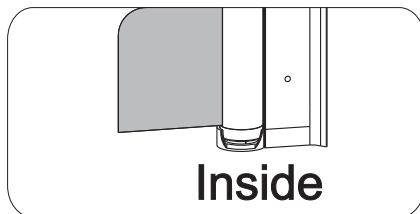
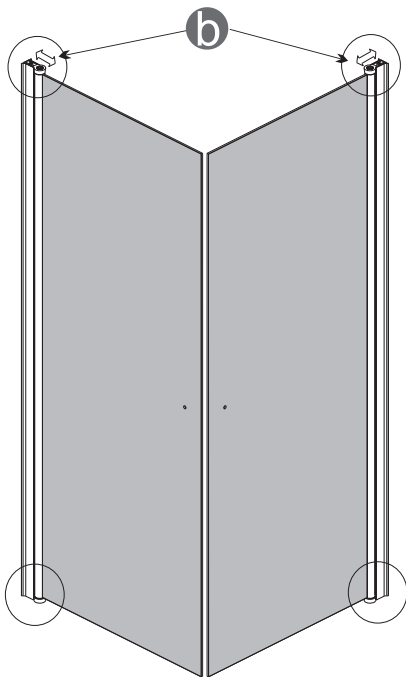
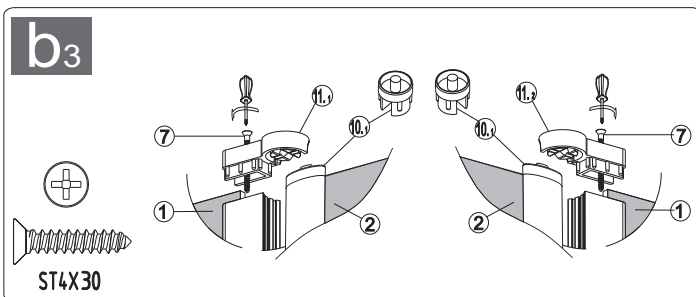
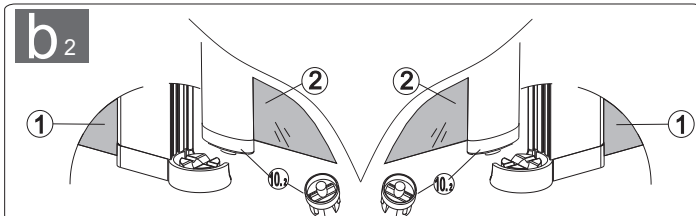
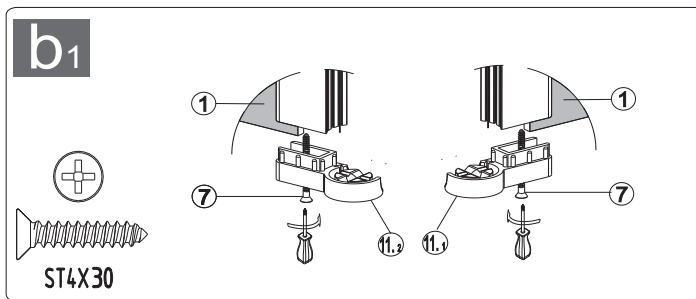

3.

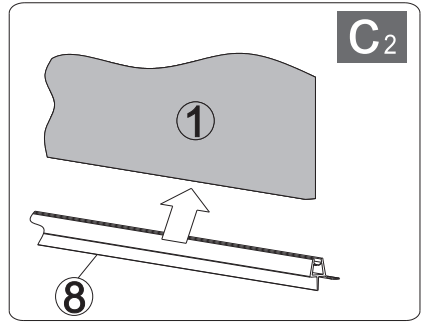
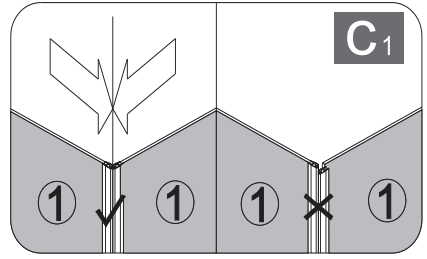
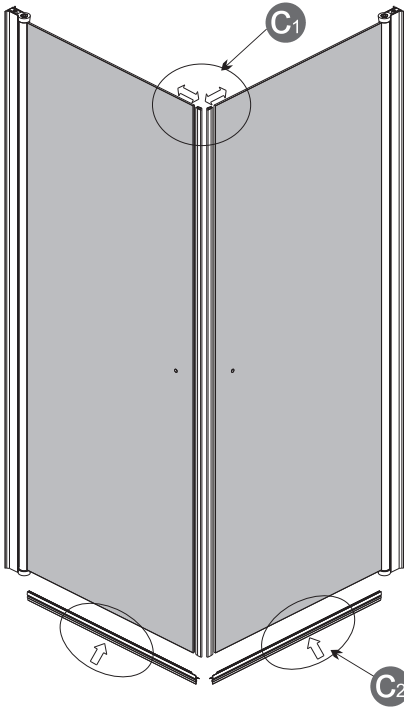

4.

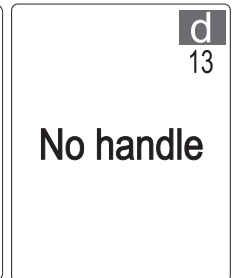
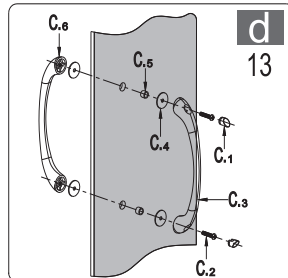
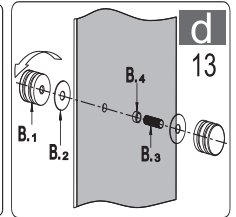
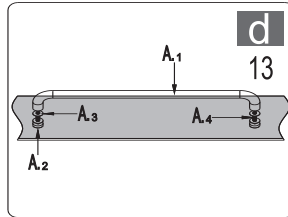
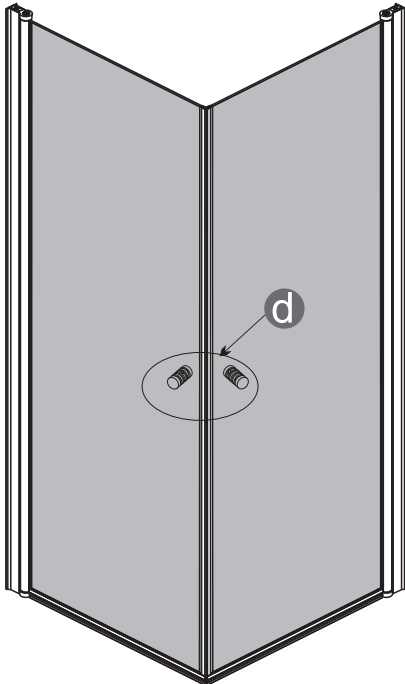

5.

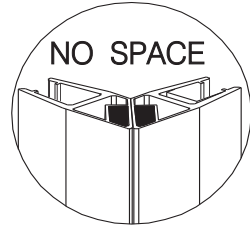
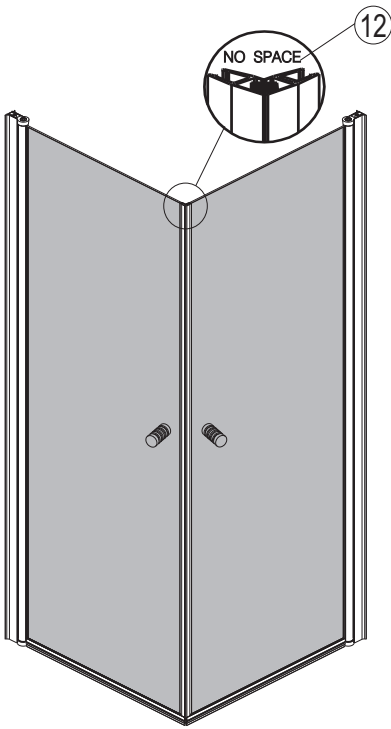

6.

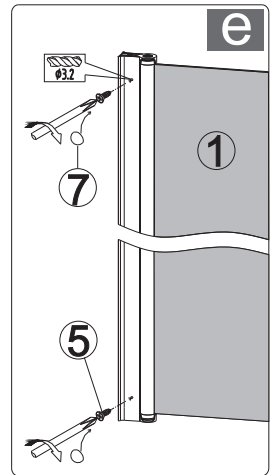
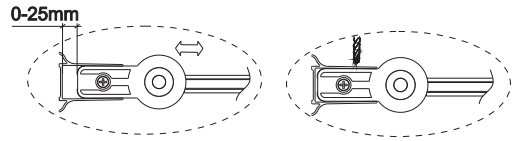
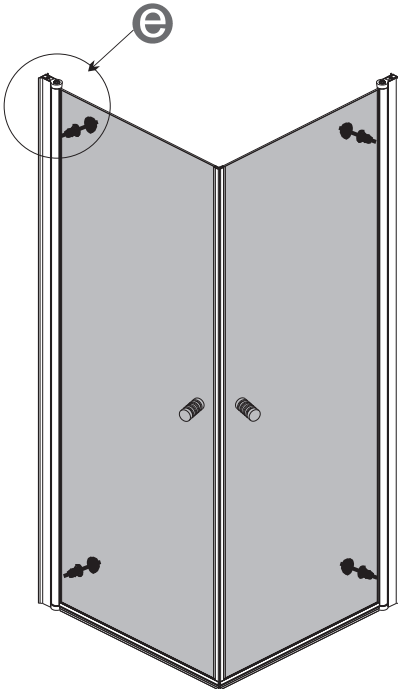

7.

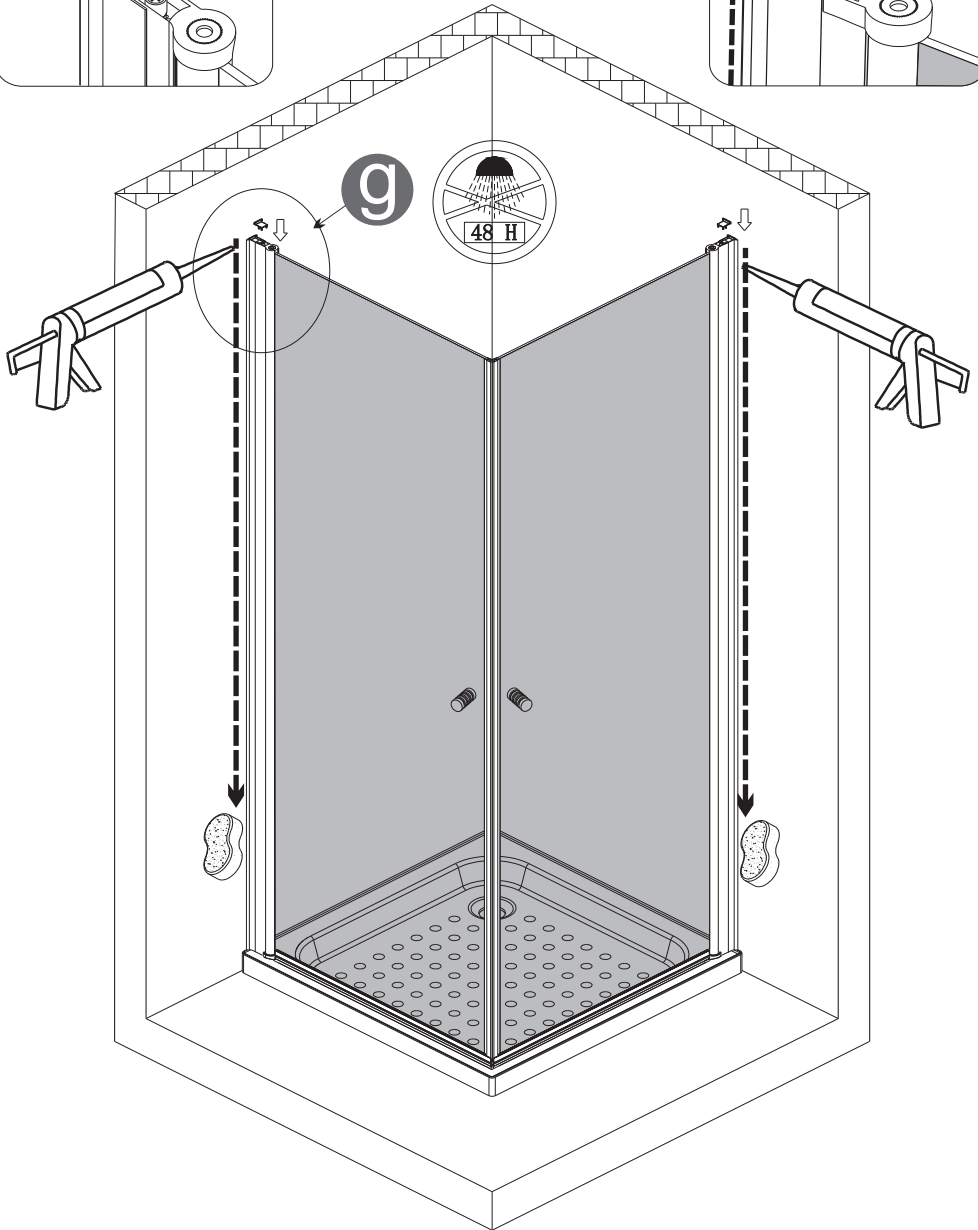
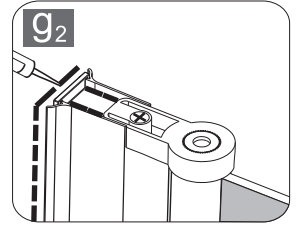
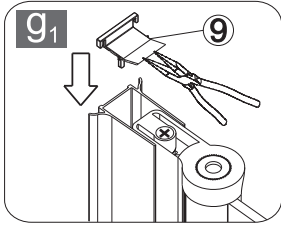



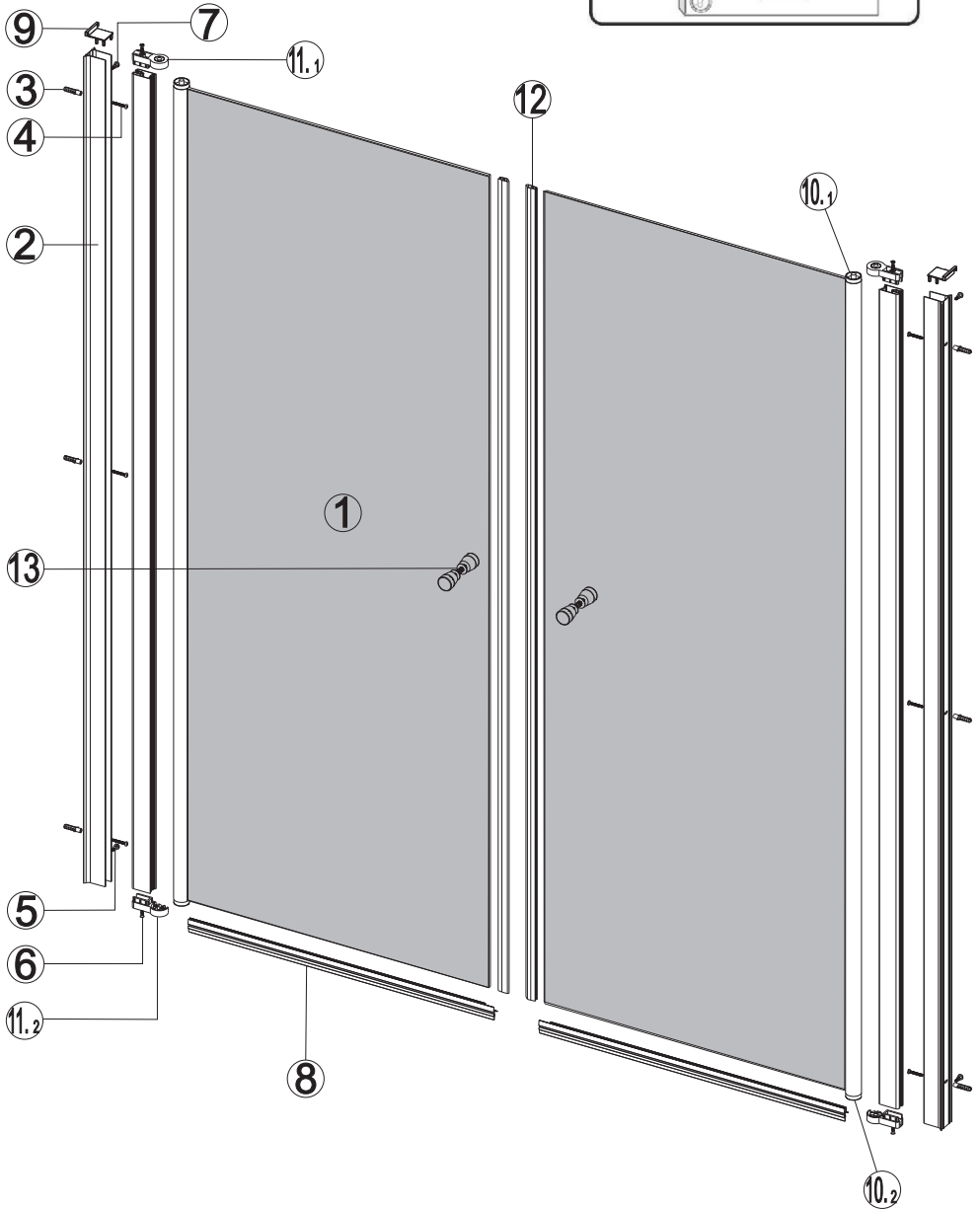
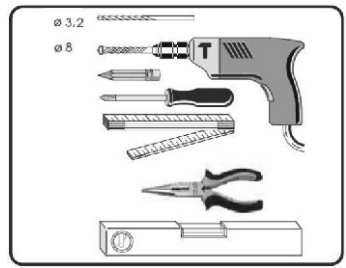
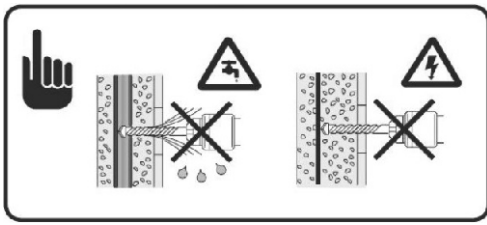

1.

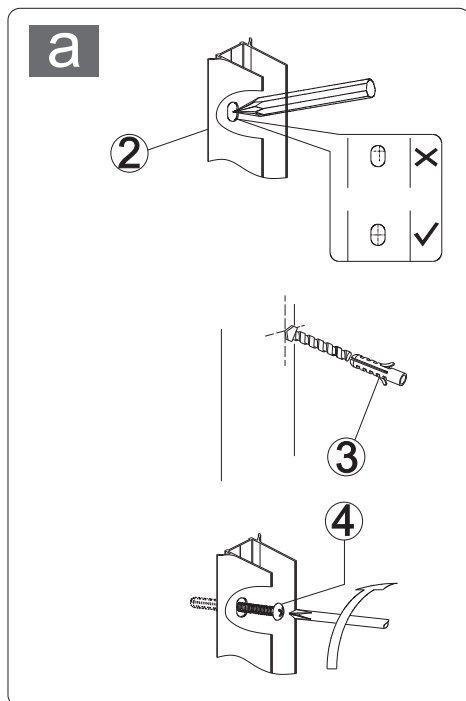
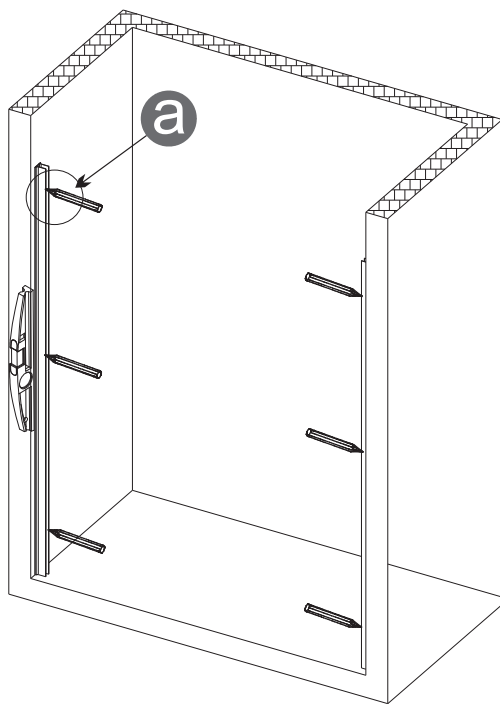

2.

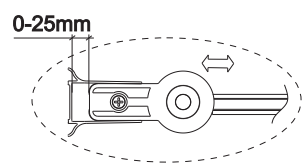
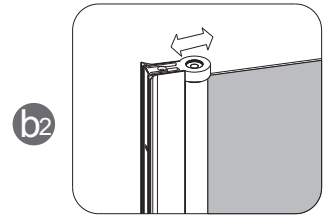
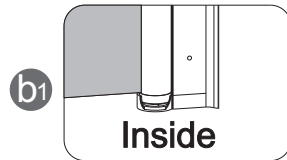
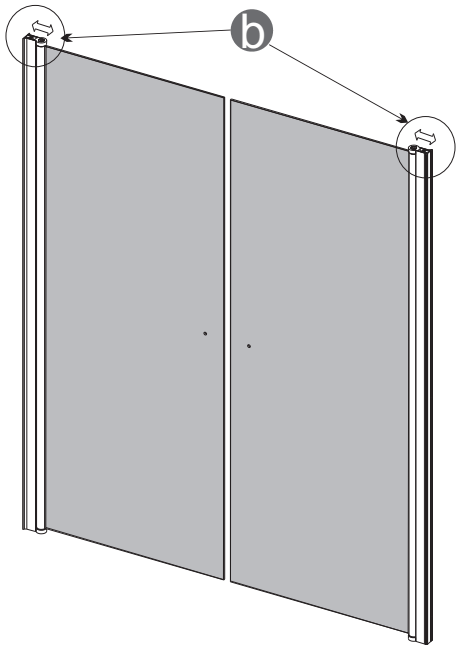
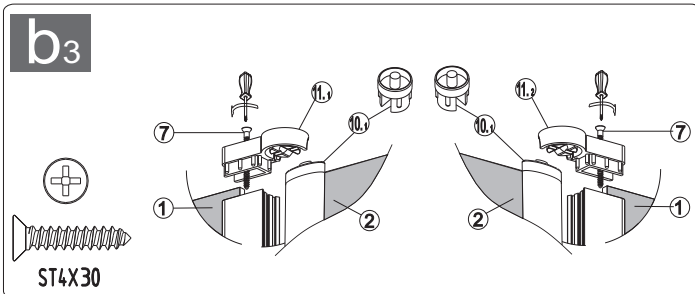
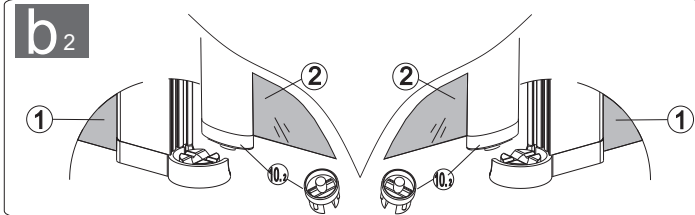
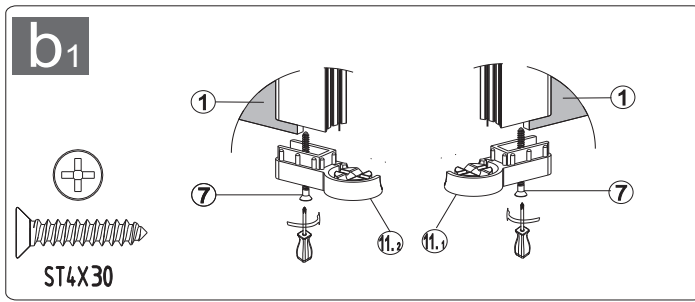

3.

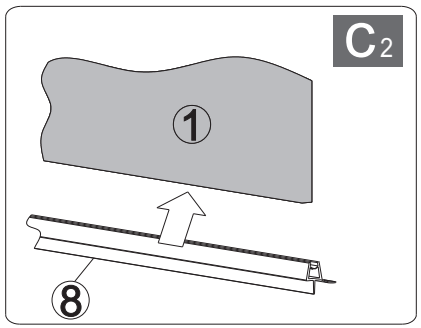
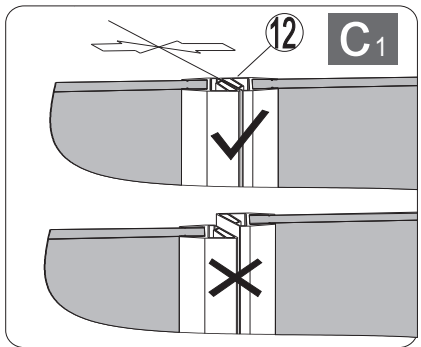
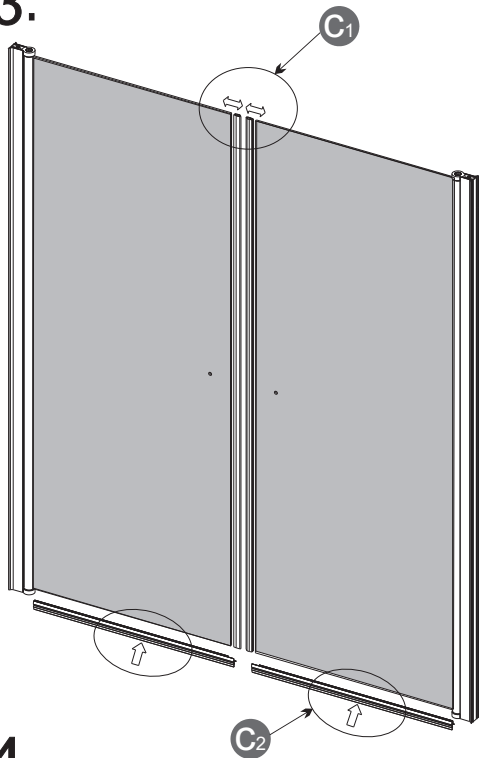

4.

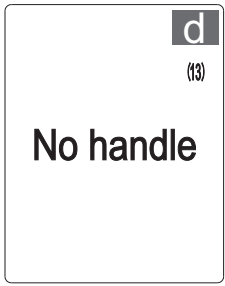
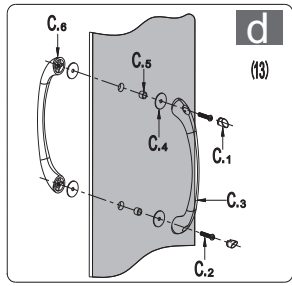
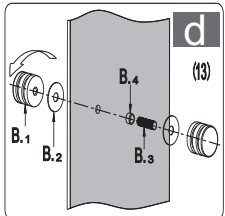
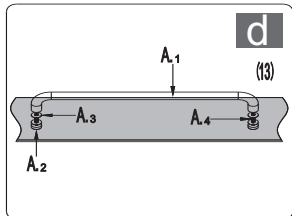
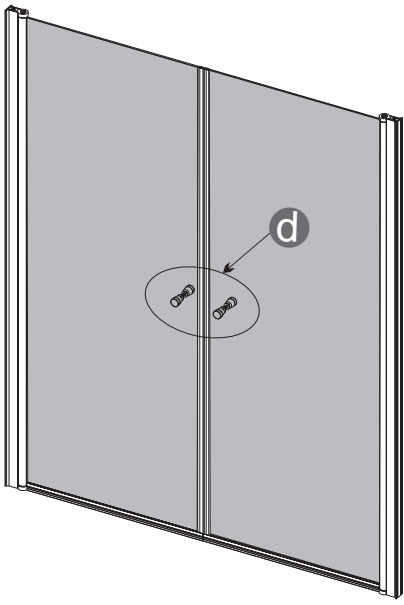

5.

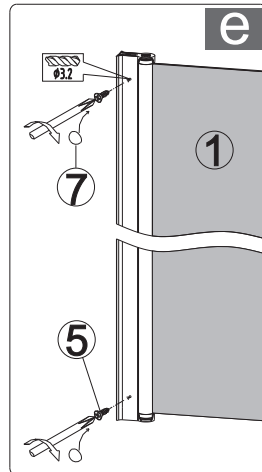
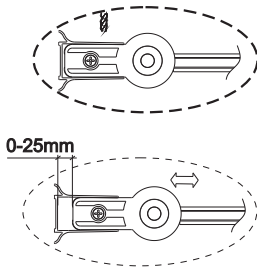
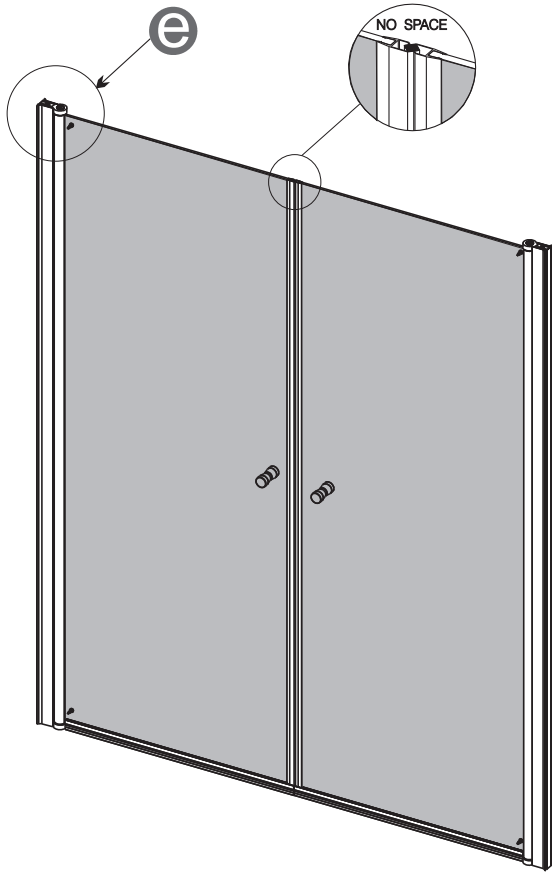

6.

